

Data Sheet

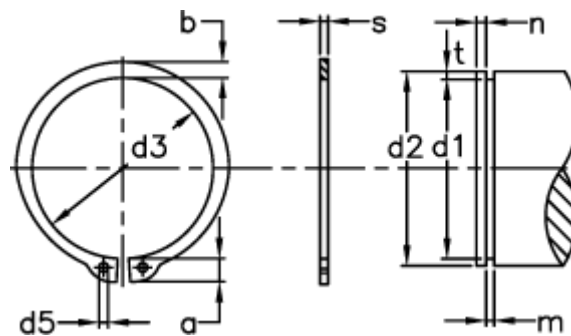

Article number: 0109090
 Description: Retaining ring AS 85x4.0
 Spring steel
 Note: Fitted with ZGA pliers

Measures



a max	= 10.0	Description	= AS 85	s	= 4.00
AN mm ²	= 458.0	FN kN	= 76.30	t	= 1.75
B	= 1.78	FRg kN	= 59.4	tol	= -0.35
b	= 7.8	FR kN	= 383.0	tol	= -0.10
d1	= 81.5	g	= 3.0	tol	= +0,46 -1,10
d2	= 85	m min	= 4.15	Tong	= ZGA-4
d3	= 79.5	n abl x 1000	= 6	Weight kg/1000	= 47.00
d5 min	= 3.5	Nominal drive	= 5.3		